



LISTINO 2010

Gipsy L



Codice	Dimensioni mm	Pz. x scat.	Peso scat.	Scatole x pallet	ml. x pallet
T- GIL	100/100/1200	13	30	15	234
T- GIL 1	150/150/1200	7	21	15	126
T- GIL 1A	200/200/1200	8	36	8	76,8
T- GIL 2	300/300/1200	5	35	9	54
T- GIL 2A135G	300/100/1200	8	36	12	115,2
T- GIL 2A	300/100/1200	8	36	12	115,2
T- GIL 2B	300/400/1200	5	40	6	36
T- GIL 3	350/150/1200	6	33	12	86,4
T- GIL 3A	500/100/1200	6	42	10	72
T- GIL 3B	600/300/1200	sfusi			

Gipsy U



Codice	Dimensioni mm	Pz. x scat.	Peso scat.	Scatole x pallet	ml. x pallet
T- GIU	100/100/100/1200	7	21	15	126
T- GIU 1	250/200/250/1200	4	32	8	38,4
T- GIU 1A	250/300/250/1200	2	18	8	19,2
T- GIU 2	250/400/250/1200	2	20	8	19,2
T- GIUM 1	300/75/300/1200	4	30	12	57,6
T- GIUM 2	400/75/400/1200	4	38	12	57,6

Gipsy Z

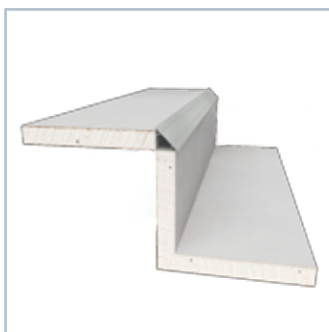

Codice	Dimensioni mm	Pz. x scat.	Peso scat.	Scatole x pallet	ml. x pallet
T- GIZ	100/100/100/1200	9	32	15	162
T- GIZ 1	50/50/50/1200	9	32	15	162
T- GIZ 2	150/150/150/1200	9	32	15	162

Gipsy Step



Codice	Dimensioni mm	Pz. x scat.	Peso scat.	Scatole x pallet	ml. x pallet
T- GISTEP 1	50/50/50/50/50/50/1200	10	30	15	180
T- GISTEP 2	100/100/100/100/100/100/1200	5	33	12	72
T- GISTEP 1S	X600	3X2	10	20	72
T- GISTEP 1A	X600	3X2	10	20	72
T- GISTEP 2S	X600	3X2	21	15	54
T- GISTEP 2A	X600	3X2	21	15	54

Gipsy Bordo Rigato



Codice	Dimensioni mm	Pz. x scatola
T- GBR 25	30+25/500/2500	sfusi
T- GBR 20	30+20/500/2500	sfusi

Gipsy solo fresato

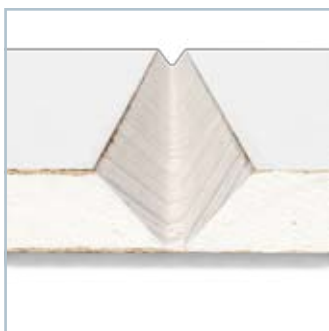

Si possono realizzare su richiesta anche di lunghezze diverse
esempio: 2 - 2,5 - 3 ml.

Codice	Dimensioni mm
T- GIL FR	100/100/1200
T- GIL1 FR	150/150/1200
T- GIL1A FR	200/200/1200
T- GIL2A135G FR	300/100/1200
T- GIL2A FR	300/100/1200
T- GIL2B FR	300/400/1200
T- GIL3 FR	350/150/1200
T- GIL3A FR	500/100/1200
T- GIL3B FR	600/300/1200
T- GIU FR	100/100/100/1200
T- GIU1 FR	250/200/250/1200
T- GIU1A FR	250/300/250/1200
T- GIU2 FR	250/400/250/1200
T- GIUM1 FR	300/75/300/1200
T- GIUM2 FR	400/75/400/1200
T- GIZ FR	100/100/100/1200
T- GIZ 1 FR	50/50/50/1200
T- GIZ 2 FR	150/150/150/1200

Gipsy Colonna Ottagonale



Codice	Dimensioni in mm
T- GIOTT5	8 LATI 50/3000
T- GIOTT10	8 LATI 100/3000
T- GIOTT15	8 LATI 150/3000

Gipsy Gizze



Codice	Dimensioni mm	Dimensioni bozza
T- GIZZE 200	2500/1200	200
T- GIZZE 300	2500/1200	300
T- GIZZE 400	2500/1200	400

Gipsy Gibo

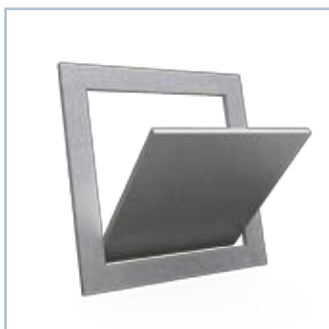

Codice	Dimensioni in mm esterno telaio	Pezzi per pallet
T- GIBO 295	435x435	68
T- GIBO 400	540X540	60
T- GIBO 530	670X670	44
T- GIBO 800/530	940X670	32

Gipsy Window

Sistema per finestre in cartongesso



Codice	Dimensioni mm
T- GIWINBR	Profilo in cartongesso per finestre con bordo rigirato



Codice	Dimensioni mm
T- GIWINL	Profilo in cartongesso per finestre ad L



Codice	Dimensioni mm
T- GIWINALU	Profilo in alluminio per copertura fermavetro per finestre



Codice	Dimensioni mm
T- GIWINFERL	Profilo fermavetro per finestre in legno

Curvo Raggi



Codice	Dimensioni Raggio	Dimensione lunghezza mm	ml per pancale
T- GIR 10	100	1500	150
T- GIR 14	140	1500	150
T- GIR 20	200	1500	72
T- GIR 25	250	1500	72
T- GIR 30	300	1500	60
T- GIR 35	350	1000	60
T- GIR 40	400	1000	40
T- GIR 45	450	1000	40
T- GIR 50	500	1000	40
T- GIR 55	550	1000	40
T- GIR 60	600	1000	40

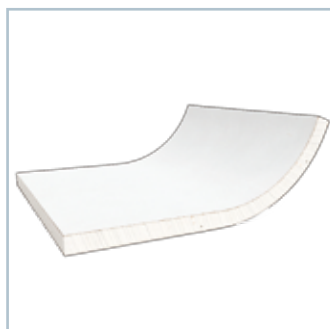

Codice	Dimensioni Raggio	Dimensione lunghezza mm	ml per pancale
T- GIR14+15	140+150 PIANO	1500	60
T- GIR20+15	200+150 PIANO	1500	60
T- GIR30+15	300+150 PIANO	1500	45



Codice	Dimensioni Raggio	Dimensione lunghezza mm	ml per pancale
T- GIR10+15+15	100+2 P.PIANE 150	1500	60
T- GIR14+15+15	140+2 P.PIANE 150	1500	60

Curvo Diametri



Codice	Dimensioni Raggio	Dimensione lunghezza mm	ml per pancale
T- GID20	200	1500	63
T- GID28	280	1500	54
T- GID40	400	1500	48
T- GID50	500	1500	36
T- GID60	600	1500	15
T- GID70	700	1000	12
T- GID80	800	1000	12
T- GID90	900	1000	10
T- GID100	1000	1000	8
T- GID110	1100	1000	8
T- GID120	1200	1000	8

-Si possono realizzare anche pancali misti
 -Le quantità e i pesi verranno comunicati alla formazione degli stessi
 -Tutti i prodotti CURVO sono confezionati su pancali in legno con forme di PSE e film estensibile per garantire il trasporto

Curvo Wave



Codice	Altezza mm	Sviluppo in pianta	Pz. per pancale
T- GIWAVE	1500	115	40

Struttura per Curvi

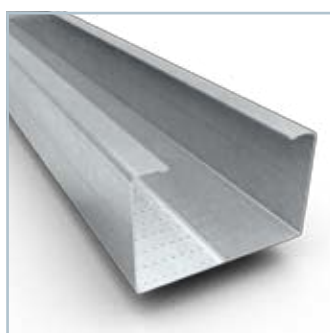

Codice	Caratteristiche
T- GIDP	Profilo curvo
	



Codice	Caratteristiche
T- GIDGF	Profilo guida flessibile

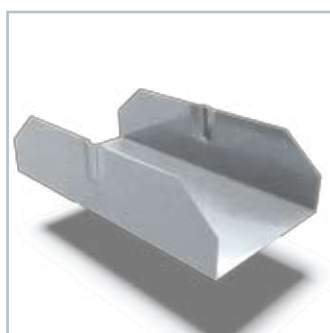

Codice	Caratteristiche
T- GIDGIU	Giunto per curvo



Codice	Caratteristiche
T- GIDCAV	Cavalotto per curvo

Struttura per Curvi



Codice	Caratteristiche
T- GIDBA28	Barra 28 per curvo
T- GIDBA40	Barra 40 per curvo
T- GIDBA50	Barra 50 per curvo
T- GIDBA60	Barra 60 per curvo
T- GIDBA70	Barra 70 per curvo
T- GIDBA80	Barra 80 per curvo



Codice	Caratteristiche
T- GIDSA28	Sagoma per GID28
T- GIDSA40	Sagoma per GID40
T- GIDSA50	Sagoma per GID50
T- GIDSA60	Sagoma per GID60
T- GIDSA70	Sagoma per GID70
T- GIDSA80	Sagoma per GID80

Frame

LISTINO 2010

Frame



Codice	Larghezza in mm.	Pz. x pallet	ml. a pallet	Peso kg pallet
T- GIMA150	150	144	360	1875
T- GIMA200	200	120	300	1560
T- GIMA250	250	96	240	1250
T- GIMA300	300	96	240	1250
T- GIMA350	350	72	180	1100
T- GIMA400	400	72	180	1250
T- GIMA450	450	48	120	950
T- GIMA500	500	48	120	1050
T- GIMA600	600	48	120	1250
T- GIMA75300*	300	64	160	850
T- GIMA75400*	400	48	120	850
T- GIMA75587*	587	32	80	830

MURETTI ARMATI CON NIDO D'APE:

tutti i pannelli sono lunghi 2500mm e di spessori da 50mm-75mm. Il cartongesso è da 9,5mm

I pacchi sono confezionati con film estensibile e cappucci su pancale in legno, si possono realizzare anche pancali misti.

*Spessore 75 mm.

Lastre accoppiate con piombo dim. 2500/600

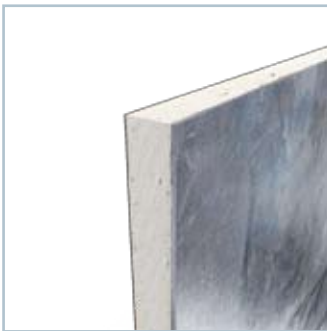

Cod. x spessore piombo	Pz. x pallet	Mq x pallet	Peso x pallet	Peso a Mq
T- PANGX250005	40	60	948	15,8
T- PANGX250010	30	45	981	21,8
T- PANGX250020	16	24	796	33,2
T- PANGX250030	12	18	803	44,6

LASTRE ACCOPIATE CON PIOMBO E CARTONGESSO 2500 X 600, il cartongesso è da 12,5 normale
- solo su richiesta si possono accoppiare lastre di piombo con pannello in cartongesso antincendio

Strisce con piombo adesivizzate 1000/100

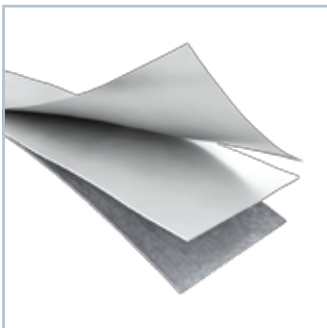

Codice	Dimensioni
T- STRIGX100005	1000/100 SP 5/10
T- STRIGX100010	1000/100 SP 10/10
T- STRIGX100020	1000/100 SP 20/10
T- STRIGX100030	1000/100 SP 30/10

Lastre accoppiate con piombo con sormonto 1230/1000

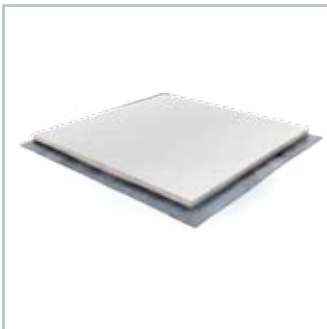

spessore piombo	Cod.	Pz. x pancale	Mq x pancale	Peso x bancale
T- PANGX123005	GX1235	42	51,66	800
T- PANGX123010	GX1210	32	39,36	850
T- PANGX123020	GX1220	24	26,52	980
T- PANGX123030	GX1230		sfuse	

Le lastre di cartongesso sono di dimensioni 1200x970 x 12,5 mm
La lamina di piombo sborda di 3 cm su due lati della lastra

Espanso Sinter Bianco

Accoppiato Cartongesso + polist. Espanso 12kgmc



Codice	Spessore lastra più isolante	Lastre per pallet	Peso Kg al Mq
T- GISP10N20	10+20	40	7,5
T- GISP10N30	10+30	30	7,6
T- GISP10N40	10+40	24	7,8
T- GISP10N50	10+50	20	8
T- GISP10N60	10+60	17	8,3

Grafite

Accoppiato Cartongesso + Grafite 15kgmc



Codice	Spessore lastra più isolante	Lastre per pallet	Peso Kg al Mq
T- GISGR10N20	10+20	40	7,5
T- GISGR10N30	10+30	30	7,6
T- GISGR10N40	10+40	24	7,8
T- GISGR10N50	10+50	20	8
T- GISGR10N60	10+60	17	8,3

Estruso

Accoppiato Cartongesso + Estruso 33kgmc



Codice	Spessore lastra più isolante	Lastre per pallet	Peso Kg al Mq
T- GISES10N20	10+20	40	8,1
T- GISES10N30	10+30	30	8,4
T- GISES10N40	10+40	24	8,8
T- GISES10N50	10+50	20	9,1
T- GISES10N60	10+60	17	9,4

Lana di roccia

Accoppiato Cartongesso + Lana di roccia 90kgmc



Codice	Spessore lastra più isolante	Lastre per pallet	Peso Kg al Mq
T- GISLR10N30	10+30	28	9,9
T- GISLR10N40	10+40	23	10,8
T- GISLR10N50	10+50	19	11,7
T- GISLR10N60	10+60	16	12,6

Lana di vetro

Accoppiato Cartongesso + Lana di vetro 85kgmc



Codice	Spessore lastra più isolante	Lastre per pallet	Peso Kg al Mq
T- GISLV10N20	10+20	40	8,8
T- GISLV10N30	10+30	30	9,6
T- GISLV10N40	10+40	24	10,4
T- GISLV10N50	10+50	20	11,2
T- GISLV10N60	10+60	17	12,4

Pannello accoppiato Lana di Vetro 30mm+PB+L. Vetro20mm



Codice per spessore piombo	Spessore Piombo	Spessore lana di vetro
T- LVPB 510	05/10	20-30
T- LVPB 1010	10/10	20-30

Ceilwall

Pannello accoppiato cartongesso 12,5 + polietilene espanso ad onda

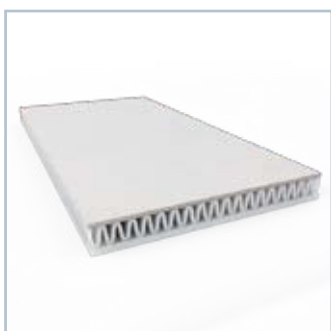

Codice	Spessore lastre cartongesso	Spessore isolante	Pz. per pancale	Peso Kg/ mq	Peso a pancale	Mq a pancale
T-CEILW35	12.5	35	25	8.6	1240	90,00
T-CEILW40	12.5	40	22	8.7	940	79,20
T-CEILW50	12.5	50	20	8.9	770	72,00
T-CEILW60	12.5	60	18	9	650	64,80
T-CEILW80	12.5	80	13	9.2	570	46,8

Tutti i pannelli sono di dimensioni 3000/1200 mm.

I pacchi sono confezionati con film estensibile e cappucci su pancale in legno.

Floor

Pannello per pavimento a secco coibentato

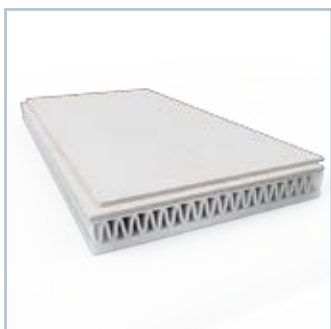

Codice	Spessore lastre gessofibra	Spessore isolante	Pz. per pancale 1200x1200	Peso Kg/ mq	Peso a pancale	Mq a pancale
T-FLOOR35	10+10	35	50	23.80	860	36
T-CEILW40	10+10	50	40	24,20	700	79,20
T-CEILW50	10+10	80	26	25,00	470	18,72

Tutti i pannelli sono di dimensioni 1200/600 mm.

I pacchi sono confezionati con film estensibile e cappucci su pancale in legno dim. 1200x1200.

Scatole acustiche per scatole 3 frutti



Codice	Caratteristiche
T- SCACU3F	Scatola acustica 3 frutti



Tubetti di raccordo con forassiti



Codice	Caratteristiche
T- SCACUTUB	Tubetti per scatola acustica

Supporti Antivibranti

Manine supporto alluminio per antivibrante



Codice	Caratteristiche
T- ANTMANO	Elementi in alluminio per antivibrante

Supporti Antivibranti

Catenella di sicurezza



Codice	Caratteristiche
T- ANTCATENA	Catenella di sicurezza

Supporti Antivibranti

Gommotto Antivibrante



Codice	Caratteristiche
T- ANTGOMMO	Gommotto per antivibrante

Nastri e Accessori per Acustica

Nastro in schiuma espansa nera



Codice	Caratteristiche
T- STGMEST175CR	Nastro in schiuma espansa sottoprofilo 5000x50

Nastri e Accessori per Acustica

Nastro in para purissima 40 shore gialla

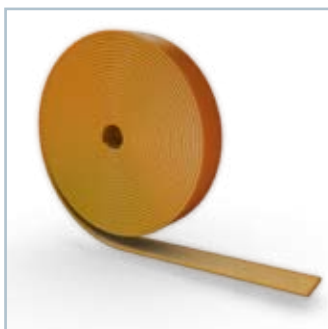

Codice	Caratteristiche
T- STGMPARA40SH	Nastro in para 40 shore sottoprofilo 5000x50

Nastri e Accessori per Acustica

Rondelle in para purissima 40 shore per fissaggio

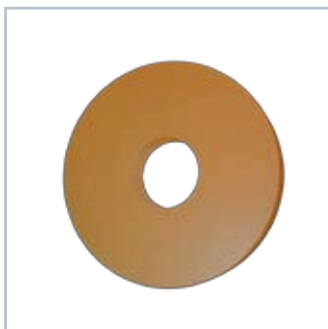

Codice	Caratteristiche
T- RONGMPAR1506	Rondella in para 5 mm per fissaggio profili



Via Falcone 14/16, 50054 Fucecchio (FI) ITALIA
Tel. 0571/241009 ric. Aut. Fax 0571/245725 www.toscopanidee.it E-Mail info@toscopanidee.it
Cap. Soc.€ 100.000,00 int. vers. P. IVA e C.F. 03048990489
Iscr. Tribunale di Firenze N. 53464 C.C.I.A.A. Firenze 294587

